

Maintenance Handbook



THE BEST WINDOWS ARE MADE FROM PROFILE 22

Introduction

Dear Customer

Congratulations on your new installation. We trust you will enjoy trouble-free use for many years to come.



As with any equipment, to obtain complete satisfaction it is advisable to carry out basic, regular maintenance.

This booklet contains useful tips and information to help you get the best from your investment.

In the event of any difficulties, your installer or local independent manufacturer will be pleased to help you.

As our policy is one of continuous improvement in products, methods and materials, changes in specification may be made from time-to-time without prior notice.

Index

Maintenance	4
Condensation	7
Security	9
Glazing	10
Window Styles	
Open-out Window	12
Tilt-Turn Window	14
Fully Reversible Window	16
Window Hardware	18
Door Styles	
Residential Door	20
Tilt & Slide Door	22
In-Line Sliding Patio Door	24
Bi-fold Door	26
Composite Door	27



Maintenance

Glass Cleaning

- Glass used in most double-glazed units is easily scratched and it is, therefore, recommended that hand jewellery is removed prior to cleaning.
- Any proprietary household cleaner may be used with a soft cloth and it is recommended that heavy external grime be initially removed with a solution of soap and water.
- Laminated glass, or glass containing Georgian bars, is cleaned in exactly the same manner.

Leaded Glass Cleaning

- In this type of double-glazing, lead strips are bonded to the outside and inside of the external pane of glass.
- Take care when cleaning leaded lights as excessive pressure might dislodge the lead from the glass surface.
- The use of warm soapy water and a soft cloth, moderately applied will prove an adequate cleaning method.

Scratched Glass

- If scratches occur, most can be removed with jewellers' rouge, or an equivalent rubbing compound.

(See pages 10 & 11 for further information on glazing.)

PVC-U Frame Cleaning

(Avoid all solvent-based or abrasive cleaners).

- Wash frames with a soap and water solution periodically to remove any grime and atmospheric deposits.
- If required, clean with Solusafe or an alternative non-abrasive proprietary cleaner to remove any stubborn blemishes.
- Take care not to disturb sealants.

Conservatory & Porch Roof Cleaning

(Avoid all solvent-based or abrasive cleaners).

- Roofing, rafters and PVC-U components fitted to these structures must be cleaned in a similar manner to PVC-U frames.
- Clear gutters of leaves and debris as required to avoid overflow of rainwater and ensure unobstructed drainage.
- Wash roof panels with soap and water solution periodically to remove grime and atmospheric deposits.

Do not walk on conservatory roofs.

Weatherseals

- During cleaning and general maintenance ensure that any hand-inserted weatherseals fitted to your products do not become dislodged from their grooves. Should this occur, slide back into position immediately to avoid damage when the product is closed.
- If the weatherseals are broken or damaged and draughts are felt around the product, ensure prompt replacement by contacting your installer.

Drainage

- Your double-glazed products are designed with an in-built drainage system, comprising slots within the thresholds that allow any water ingress to flow to the outside. To ensure an efficient system these slots must remain unblocked.
- Periodically, remove dirt, clear the drain slots (situated in the frame rebates) and check drainage operation by flushing through with water.

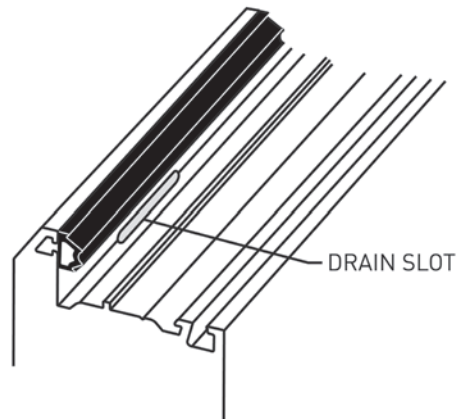

Lubrication

To attain optimum performance, it is essential that all hardware is lubricated every 6-12 months (depending on location).

For lubrication of hardware etc, use light machine oil (e.g. 3-in-1 lubricant) for moving parts and petroleum jelly where indicated in the product specific lubrication instruction.

Silicone Seal

Please note that some discolouration of the Silicone seal is a natural occurrence and cannot be avoided.

Brasswork

When installed, brasswork is fully protected with lacquer. In time and through normal wear and tear, this lacquer may peel or become tarnished.

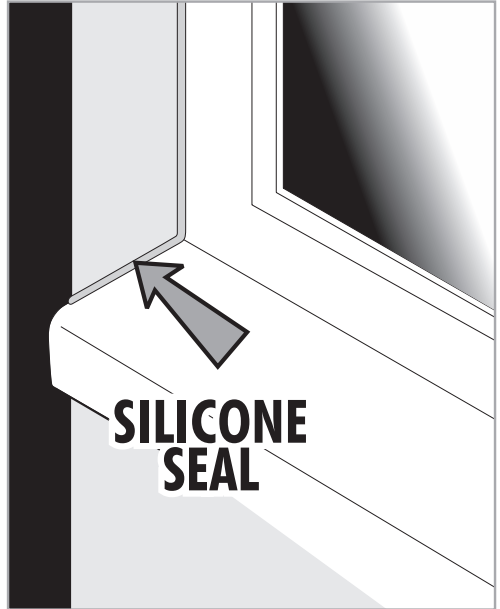

Note: Your installer cannot accept responsibility for this natural occurrence.

To refurbish your brasswork carry out the following procedure:

- You are advised to protect the PVC-U surfaces from chemicals etc, by masking off an area around each piece of brasswork.
- Remove old lacquer with nail polish remover/paint stripper.
- Clean and polish with a suitable proprietary brass polish.
- Carefully re-lacquer with a good quality product.

Condensation

In general climatic conditions water vapour is continually present in the atmosphere. In the home this natural water content is increased by normal living activities that create steam, such as cooking, bathing, washing, boiling a kettle etc, plus the basic activity of breathing.

The water vapour remains undetectable while floating in warm air; but upon contact with cold surfaces, windows, mirrors, tiles etc, condensation occurs and the vapour turns to water droplets.

Fitting double-glazing does not necessarily solve underlying condensation problems.

Traditional house construction allowed the escape of this water vapour through natural ventilation - open flues of coal fires, air bricks and ill-fitting windows and doors.

The drive to conserve energy and reduce heating costs has led to the sealing of homes, resulting in trapped water vapour and increased problems of condensation.

The advent of more energy-efficient double-glazed units can, in certain circumstances, lead to condensation being evident on the OUTSIDE of the window.

Ventilation

Provide natural ventilation whenever possible by:

- **Opening a window**
- **Fitting a ventilator/extraction unit in the kitchen and bathroom.**
- **Fitting wall vents to provide air flow.**

NB: Security should be borne in mind when leaving a window open.

Heating

- Maintain some permanent heat in the house during cold weather. Marginally increase the temperature in areas where condensation is a particular problem.
- If possible, fit radiators under windows to maintain the temperature of the inside pane of your double-glazing

Circulation

Water vapour will easily drift on convection currents far from where originated.

- Keep internal doors to kitchen and bathroom areas closed and draught-sealed, where possible, to prevent the excessively moist air in these rooms being transferred to other areas of the house.
- Bedroom windows should have a night ventilation facility to provide air movement. Ideally, if bedroom doors are closed, a ventilation grille should be installed in or above the door also.
- To ensure air flow in the vicinity of windows, curtains should be a minimum of 150mm (6") away from the window, with suitable gaps, top and bottom, to allow circulation.



Prevention is better than cure

Your double-glazed windows and doors have been specifically designed to include a variety of security features to protect your home and family against intrusion.

We recommend a number of sensible precautions which should be taken to gain full advantage of the security features available with your double glazing:

- **Never leave a window open when your home is unattended.**
- **For added protection, lock all windows in the closed position and remove the keys.**
- **To provide adequate means of escape in the event of any emergency, we recommend that keys to all windows are located adjacent to the window, but out of external view.**
- **When leaving the house unattended or at night, ensure door handles are fully lifted and that the keys are turned to throw and lock all deadbolts/hookbolts for full security.**



Glazing

All double-glazed units are susceptible to a degree of surface damage during the glass manufacturing process. Certain imperfections in the glass cannot be avoided, even in the most carefully controlled production environment.

Blemishes and imperfections are inherent in all double-glazing, and are acceptable within the highest standards of the industry.

We wish to draw your attention to the following extract from an industry accepted standard, relating to glass generally.

1. Transparent Glass, used in the manufacture of double-glazed units is identical to that used in traditional single-glazing and will therefore have a similar level of quality.
2. Both panes of the double-glazed unit shall be viewed from the room side, standing at a distance of two metres (6'6" approx) in natural daylight and not in direct sunlight. The area to be viewed is the normal vision area, with the exception of a 50mm (2") wide band around the perimeter of the unit.

NB: The appearance of modern low 'E' glass units, in certain sunlight, may present a "smokey hue". This appearance is perfectly normal. It is due to the metallic layer on the inner surface of the outer pane of glass.



3. Flat Transparent Glass shall be deemed acceptable if the following phenomena are neither obtrusive or bunched:
 - a. Totally enclosed seeds.
 - b. Bubbles or blisters.
 - c. Hairlines or blobs.
 - d. Fine scratches, not more than 25mm (1") long.
 - e. Minute embedded particles.
4. Obtrusiveness of blemishes shall be judged by looking through the glass and not at it, under normal lighting conditions as described in point 2.

Extracted from the Glass & Glazing Federation Standards.

Glass Defects

Your installer uses only the highest quality float glass available, whether laminated, toughened or annealed, which conforms to the requirements of BS6262.

Patterned Glass

This glass originates in very large sheets and due to spacing repetition, centralisation of any design in a specific window, cannot be guaranteed



Window Styles

Open-out Window

This window may be opened outwards with its friction hinges holding it in a desired position. Locking is achieved by the mushroom cams and/or the shootbolt pins of the locking mechanism, fitted to the opening edge of the window, engaging into the keeps fitted to the outer frame.

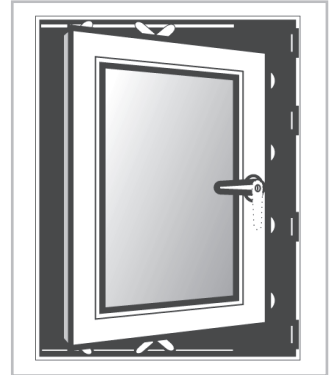

These keeps usually have secondary slots incorporated within them, which when engaged provide a 'Night Vent' position. This allows the window to be slightly open, providing trickle ventilation.

- Accessible windows should not be left in the night vent position when the house is unoccupied.

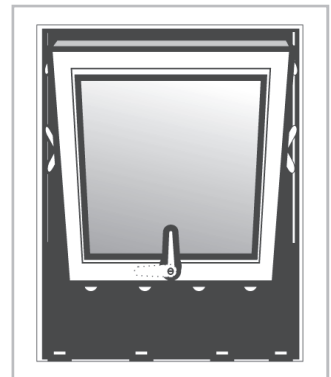

Operating Instructions

- If fitted, turn key or depress button to unlock the locking handle. Handles with different key/button operating sequences may be fitted. Check with your installer for instructions.
- Rotate the handle through 90° to disengage locking mechanism and open by pushing outwards.

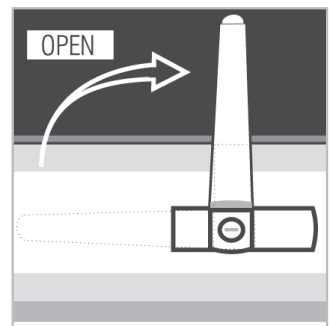

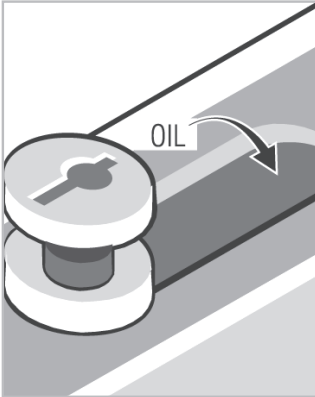

Lubrication - As Required

Oil all pivot points (one drop per pivot is sufficient) and wipe away excess.

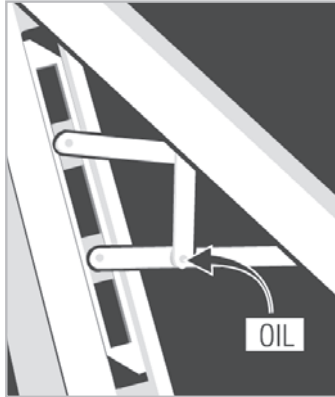

Friction Hinges

To attain optimum performance, the scissor mechanism of the friction hinges will require periodic lubrication. The pivots, sliding shoe and track should be kept free of dirt and debris.

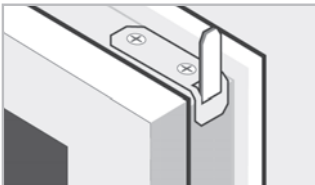

Espagnolette Locking Mechanism

Lubrication - As Required
Keep sliding mechanism free of dirt and lubricate each slot with light machine oil.

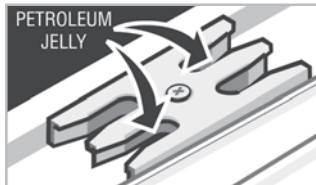

Keeps

Lubricate the slots of the keeps with petroleum jelly as required.

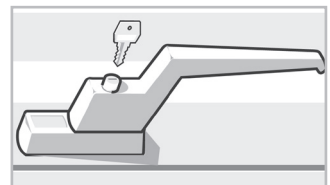

Espagnolette Handles

Clean and lightly oil moving parts.

Tilt-Turn Window

These versatile inward opening windows are capable of two modes of operation.



- Tilt mode for ventilation.
- Turn mode for cleaning and emergency exits.

The term 'Tilt-Turn' refers to the sequence of operation of the window which is designed for safety, to initially select the 'Tilt' mode, followed by the 'Turn' mode.

Locking is achieved by a series of cams or espagnolettes, located on a sliding mechanism around the edge of the window. When shut and the handle 'closed' position is selected, the cams engage into keeps fitted around the outer frame, providing a secure locking system and excellent weathersealing.

Note: These windows can also be supplied in the Turn-Tilt (AKA Tilt and Turn) mode, whereby the sequence of operation is reversed. If you are in any doubt as to the sequence of operation please contact your installer.

Operating Instructions

To operate the window, the handle is placed in one of three positions, 'Closed', 'Tilt' or 'Turn'.

The operation sequence commences with the window in the 'Closed' position (Handle vertically downwards).

Note: The window must always be fully shut before changing the handle position.

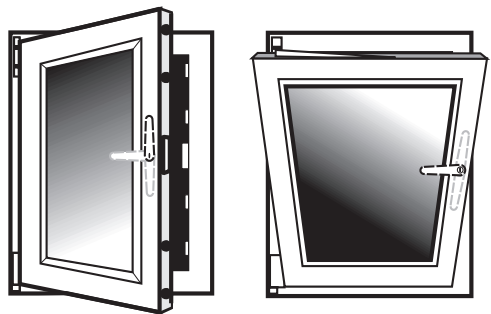

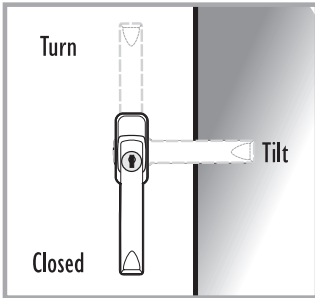

- If fitted, turn key to unlock.
- To select 'Tilt', rotate the handle through 90° from vertically downwards to horizontal and pull the window inwards. The bottom remains hinged to the frame, while the top tilts inwards to allow ventilation.
- To select 'Turn' from the 'Tilt' mode, close the window and rotate the handle from its horizontal position to vertically upwards and pull the window inwards. The side remains hinged to the frame, while the window may be opened inwards to any desired position.
- To select 'Turn' from the 'Closed' position, rotate the handle through 180° from vertically downwards to vertically upwards and pull the window inwards.

Switch Barrier

The switch barrier projecting from the locking mechanism, adjacent to the handle, is a safety device which ensures that only one mode, 'Tilt' or 'Turn', can be selected at any one time by securing the handle into the selected mode, while the window is open. Avoid pressing the switch barrier as this action releases the handle and could allow it to be inadvertently rotated to the alternative mode, resulting in the window disengaging from its gear.

Always firmly push the opening leaf into the window frame before changing the handle position.

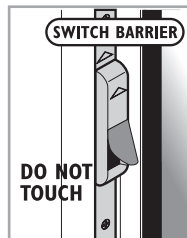

Tilt-Turn Locking Mechanism

Keep sliding mechanism free of dirt and lubricate each slot with light machine oil as required.

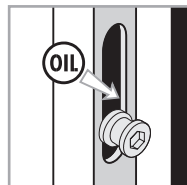

Keeps

Lubricate the faces of the keeps with petroleum jelly as required.

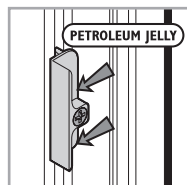

Handles

Clean and lightly oil moving parts.

Fully Reversible Window

The window rotates through 180° to allow internal cleaning of the external pane.

Safety catches limit the initial opening and operate again at full rotation. Locking is achieved by multi-tongue bolt espagnolette mechanism.

Lock keeps also allow a 'Night Vent' position, providing more secure ventilation.

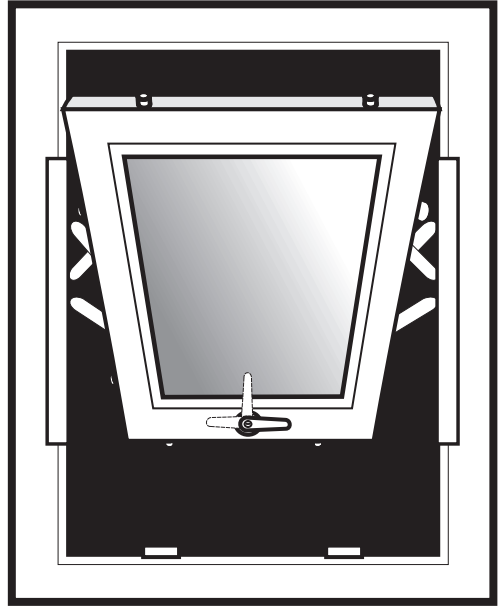

Operating Instructions - To open for night vent.

Turn key to unlock. Rotate handle 90° to vertical, open slightly and close handle to engage night vent slots.

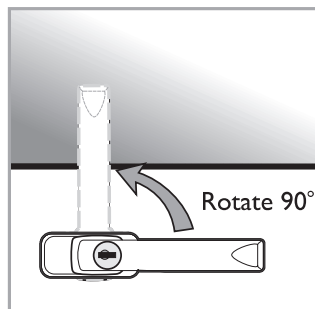

To Open for Restricted Ventilation (Spilka Gearing Only)

Operate handle and push outward until catch engages.

To Rotate for Cleaning

Disengage catch (by pushing catch upwards) and push outwards while pulling top down and rotate window until catch re-engages.

To Rotate to Close

Disengage catches and push top outwards while pulling bottom up to return to closed position. Pull inwards and operate handle to fully close. Turn key to lock.

To open for Restricted Ventilation (PN/Yale (Grorud) Gearing Only)

Operate handle and push outward until catch engages.

To Rotate for Cleaning

Disengage catch (by pushing the button located on the jamb marked "PRESS" until it passes the two stops in the channel) and push outwards while pulling top down and rotate window until catch re-engages.

To Rotate to Close

Disengage catches (by pushing the button located on the jamb marked "PRESS") and push top outwards while pulling bottom up to return to closed position. Pull inwards and operate handle to fully close. Turn key to lock.

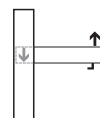
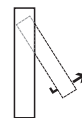
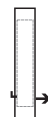
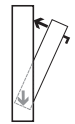
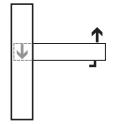
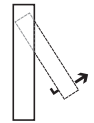
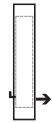
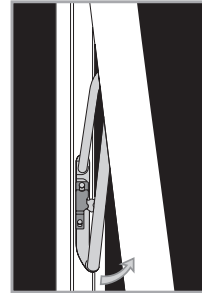

Lubrication

- All pivot points in the hinge should be kept lightly oiled.
- Lightly grease the vertical tracks.
- Lubricate the keeps with petroleum jelly.

Window Hardware

Restrictor

If fitted, the restrictor limits the opening of the window to control ventilation. The restrictor may be disengaged to allow the window to be fully opened. There are two main types of restrictor, the standard casement restrictor and the security restrictor.

CASEMENT WINDOW RESTRICTOR-ENGAGED

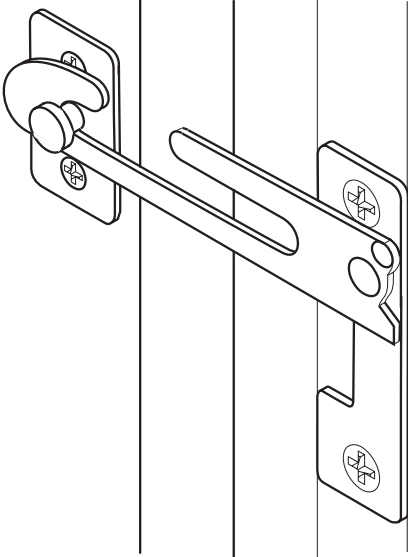

Standard Casement Restrictor operating Instructions

To Open - Restricted.

- Operate handle and open window.
The restrictor arm will limit opening.

To Open - Fully

- Once opened to the restricted position, close the window slightly and manually release the restrictor by lining up the slot opening with the striker post. While holding the restrictor latch, open window fully.

To Close

- Close the window in the normal manner. The restrictor will automatically re-engage.

Security Restrictor Operating Instructions

A special key is supplied to provide adjustment for the swinging arm and to enable the unit to be locked.

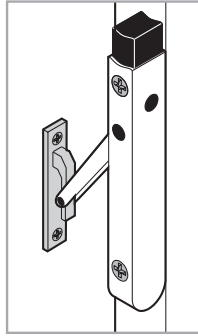

To Open - Restricted

- Select required mode and open window. Restrictor arm will limit opening.

To Open - Fully

- Close window.
- While holding down control button, re-open window.
- Release button as soon as window has cleared frame.

To Close

- Close the window in the normal manner.
- The restrictor will automatically re-engage.

To Lock Restrictor

- Insert special key at the back of the unit and rotate clockwise half a turn.

Note: To provide adequate means of escape in the event of any emergency, we recommend that keys to all windows are located adjacent to the window, but out of external view.

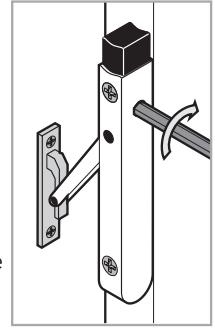

To Adjust Swinging Arm

- Insert the key into socket at the side of the unit and rotate clockwise to tighten swinging arm or anti-clockwise to loosen.

Note: that in the unlikely event that adjustment is needed, only a small movement (1/4 turn) will be required.

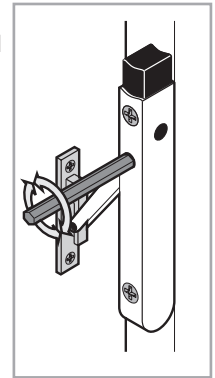

Door Styles

Residential Door

Doors may be fitted with lever/pad handles that limit outside opening by use of a key, or lever/lever handles allowing external opening by handle movement.

High-security locking systems generally comprise multipoint deadbolts of various types, and a latch lock, which engaged in keeps fitted to the frame jamb.

The deadbolts are engaged by lifting the handle.

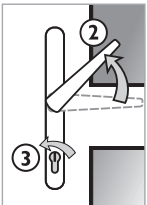
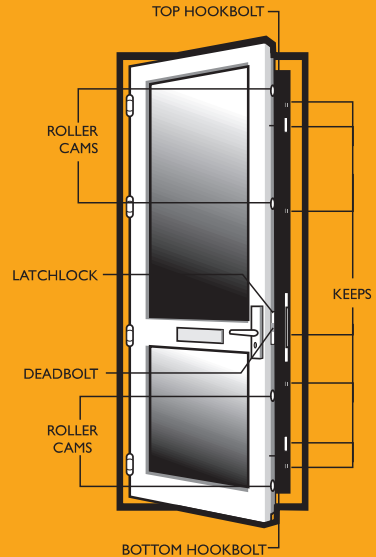

To Lock

1. Close the door - latchlock engages.
2. Fully lift the handle or pad to engage the top and bottom deadbolts/ hookbolts/ rollers.
3. Insert key and turn to engage centre deadbolt and fully lock.

If the key will not turn lift handle or pad to maximum position and then turn key.

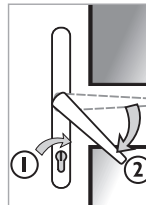

To Unlock

1. Insert key and turn to unlock.
2. Press handle or pad down to disengage top and bottom deadbolts/ hookbolts/rollers.
3. With lever handle, door will open.
4. With pad handle, continue to turn key to open.

Lubrication - As Required

Locking Mechanism

- With the door open, lubricate the deadbolts/ hookbolts/rollers and latchlock with light machine oil.

Hinges

- Clean and lightly oil hinge pins. If hinges are external (Open-out door) lubricate every six months.

Handles

- Clean and lightly oil external moving parts.

Lock Cylinder

DO NOT LUBRICATE (packed with special grease).

Double Doors

Dependant on locking mechanism there are two slave door locking options:

Full Slave Locking

- A handle operated shootbolt lock operating in the same way as the master door (see page 19).

Fingerbolts

- Hand operated fingerbolts are fitted to the top and bottom of the slave door.

Lubrication - As required lightly oil external moving parts.

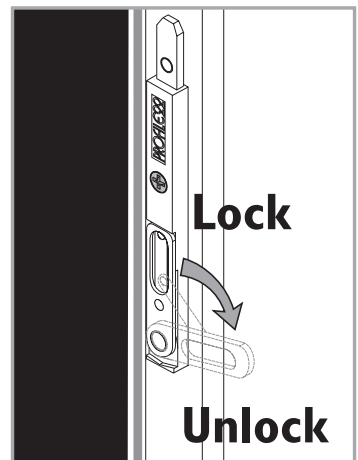
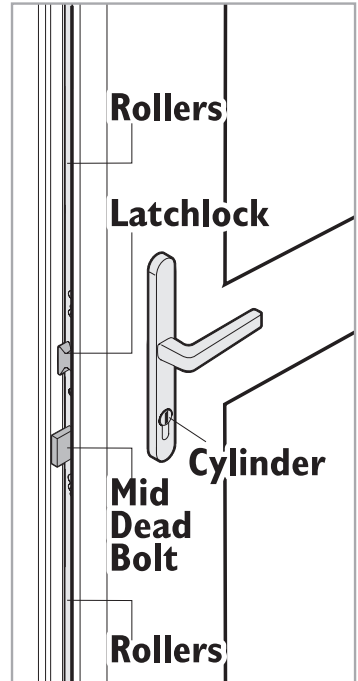

Tilt & Slide Door

This versatile inward opening door can be 'Closed', placed in the 'Tilt' mode for ventilation, or in the 'Slide' mode to clear the doorway for access.



Locking is achieved by a series of cams, or espagnolettes located on a sliding mechanism around the edge of the door. When shut and the handle in the 'Closed' position, the cams engage into the keeps fitted around the outer frame, providing a secure locking system and excellent weathersealing.

In addition the 'Tilt' mode may be selected and locked to provide secure ventilation, with a degree of security.

Operating Instructions

To operate, the handle is placed in one of three positions, 'Closed', 'Tilt' or 'Slide'.

Closed (locked) to 'Tilt' (locked)

Insert key and rotate to unlock. Move handle 90° to horizontal (top of door will tilt inwards). Rotate key to lock and remove.

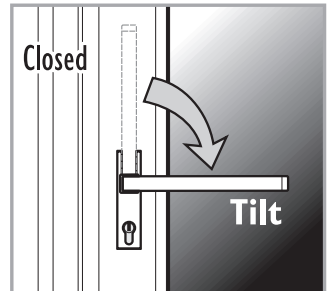

Closed (locked) to 'Slide' mode

Insert key and rotate to unlock. Move handle 90° to horizontal and press spring loaded handle down and release. (Door will eject from doorway.) Slide door on track to clear access.

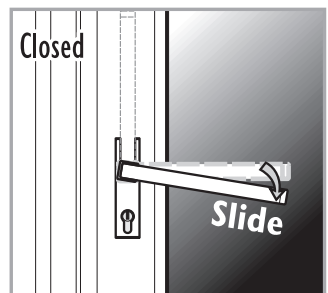

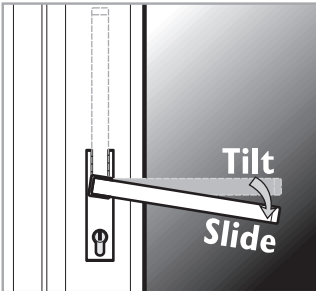

Tilt (locked) to 'Slide' mode

- Insert key and rotate to unlock.
- Press spring loaded horizontal handle down and release (Bottom of door will eject from doorway).
- Slide door on track to clear for access.

Lubrication - As Required.

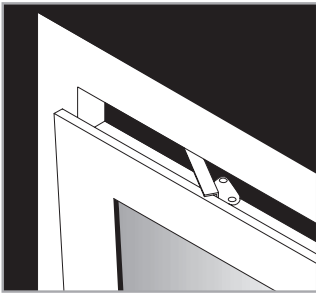

Runner Arms and Stay Arms

- With door in slide mode, lubricate the moving parts of the bottom runner arms and top stay arms with light machine oil.
- Ensure mechanism is free of grit.

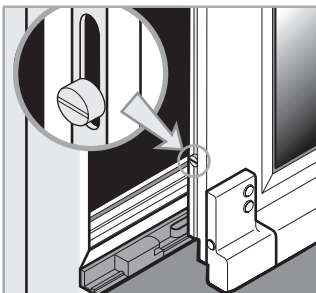

Locking Mechanism

Lightly oil locking cam slots.

Bottom track - Do not lubricate

Ensure track is permanently clear of dirt and debris.

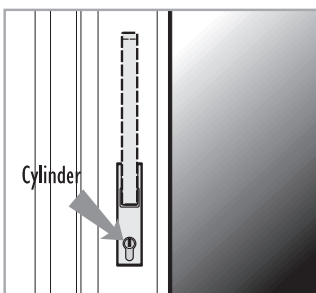

Handles

Clean and lightly oil external moving parts.

Lock Cylinder - Do not lubricate

(Packed with special grease).

In-Line Sliding Patio Door

Patio doors are designed to be very low maintenance. The general service and maintenance tasks recommended are simple to carry out and do not require specialist skills, tools or equipment.



Operating Instructions

To Lock

- Slide door to fully closed position.
- Lift lever behind handle. (Bolts and Cams will engage to lock the door.)
- Turn key to deadlock locking mechanism.

To Unlock

- Insert the key in cylinder and rotate to unlock the mechanism.
- Depress lever behind handle. (Bolts and cams will disengage).
- Slide door open.

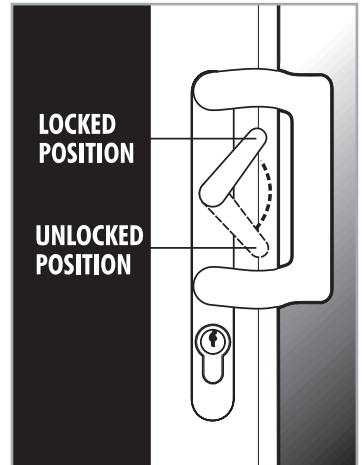

Lubrication - As Required

Oil the locking cams of the mechanism.

Lock Cylinder

Do not lubricate (packed with special grease).

Bottom Track

Keep permanently free of dirt and obstruction. Ensure that drainage slots are clear of debris.

Weatherseals

During cleaning ensure that any hand-inserted weatherseals fitted to your products do not become dislodged from their grooves. Should this occur, slide back into position immediately, to avoid damage when the door is closed. If the weatherseals are broken or damaged and draughts are felt around the pro-duct, ensure prompt replacement by contacting your installer.

Following the initial installation the weatherseal may require bedding in; causing a slight resistance when operating the door, the application of a silicone spray will aid the smooth operation of the door during this period.

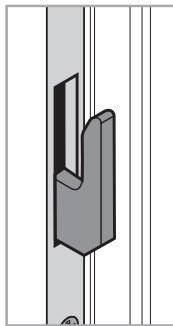
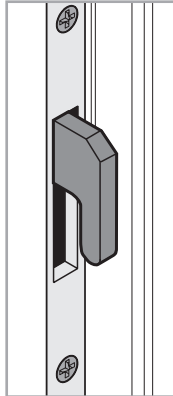

Outer frame and Sash maintenance

Wash the frame with a soap and water solution, periodically as required, to remove any grime and atmospheric deposits. If required clean with a non-abrasive proprietary cleaner, suitable for plastics, using a soft cloth. Stubborn marks can be removed with a stronger, non-abrasive, proprietary cleaner such as a cream. Always take care not to disturb sealant.

At least every four months, clean the internal and external surfaces of the frame and glass (or glazed panel(s)) to remove atmospheric grime; always use a soft cloth with mild liquid detergent solution, rinse with water and dry off. Periodically check that visible external drainage holes are free from any obstruction; if blocked, remove obstruction and flush through with water to ensure correct drainage.

Bi-Fold Door

Bi-fold doors are great space savers. They are designed to be very low maintenance. The general service and maintenance tasks recommended are simple to carry out and do not require specialist skills, tools or equipment.



Adjustment of mushroom cams

To achieve optimum weathering performance, pressure on spring latch and acceptable handle operation, adjust the striker/cam with an appropriate size spanner/hexagon key.

Lock lubrication

Clean and lightly grease external moving parts and frame keeps annually.

Cylinder

Do not attempt to lubricate the locking cylinder.

Hinge lubrication

Clean and lightly oil hinge pins annually. If open-out type, lubricate hinge pins every six months.

Hardware lubrication

Clean and lightly grease all locking points and the inside top and bottom track bearing surface annually with petroleum jelly.

Handles

Clean and lightly oil external moving parts annually.

Composite Door

Composite door sets are designed to be very low-maintenance. The general service and maintenance tasks recommended are simple to carry out and do not require specialist skills, tools or equipment.

Lever handles

On an annual basis clean and remove dirt and debris from moving parts. Lightly oil external moving parts with a light machine oil.

NOTE: Do not use a metal polish. Do not use any abrasive cleaning products or a wire brush.

For stubborn stains, use a soft cloth with mild liquid detergent solution, rinse with water and dry off.

Polish with a quality wax furniture polish. Apply the polish to the cloth and not the product.



The best windows
are made from
PROFILE 22



BS EN ISO 9001
FM09180



BS EN ISO 14001
EMS86980



BS OHSAS 18001
OHS523157



BES 6001
Responsible Sourcing
www.greenbiz.com/greenbiz
Licence No. BES 583816



Official Police Security Initiatives



BS EN 12608
KM12695
PROFILE
SUPPLIER



BS EN 12608/PAS24
KM35223
ENHANCED SECURITY
WINDOW SYSTEMS
SUPPLIER



BS EN 12608/PAS24
KM56791
ENHANCED SECURITY
DOOR SYSTEMS
SUPPLIER



BS 8529/PAS24
KM594776
ENHANCED SECURITY
DOOR SYSTEMS
SUPPLIER



BBA Approved Supplier
PROFILE22

PROFILE 22 is an international PVC-U profile system supplied to local independent manufacturers and installers who contract to install windows, doors and conservatories.

PROFILE 22 SYSTEMS cannot be held accountable for manufacture or installation by independent companies. All information in this publication is provided for guidance only and is given in good faith. As it is company policy to continually improve products, methods and materials, changes of specification may be made from time to time without prior notice. This statement does not affect your statutory rights. © PROFILE 22. Part of the Epwin Group.

